



ENGINEERED FOR THE WORLD'S HARSHTEST CLIMATES



You Deserve It!

Customer needs, innovative engineering, employee dedication and our amazing dealer network is the foundation of our success.

Our Team always strives to find innovative solutions to make the hot tub experience easy, fun and unforgettable for our customers.

 **EY Entrepreneur
Of The Year®**

**2019 PRAIRIES REGION WINNER
MANUFACTURING AND OVERALL**

ENJOY THE LUXURY OF YOUR OWN PERSONAL SPA IN



**HEAL YOUR BODY, SLEEP BETTER,
MAKE TIME WITH**



THE COMFORT OF YOUR OWN HOME.



MELT STRESS AWAY, AND FAMILY AMAZING.

You Deserve It!

5

TOP COMMONLY ASKED QUESTIONS

Shopping for a Spa should be an easy experience. Keep in mind you are looking for the ultimate experience and long-term efficiency. Here are the top 5 commonly asked questions.

1. What should I consider and look for when investing in a Spa?

Ask yourself how you will be enjoying your time in your new Spa with family and friends. This will help determine the size and mould design best suited for your needs. Spa construction and longevity, technology and wi-fi connectivity, monthly energy costs, tub maintenance, warranty, serviceability and your budget. We can help!

2. Is it expensive and hard to maintain a Spa?

There have been many engineering advances that minimize costs and make maintaining ideal spa conditions with minimal effort. Arctic Spas® has solutions for these valid concerns with our FreeHeat™ and Spa Boy® technology greatly lowering your monthly energy costs and to help maintain ideal spa conditions.

3. How long will my Spa last?

Detailed construction of the shell, cabinet, insulation system and components used all add to the life span of your Spa. Asking about construction is important and time should be taken to discuss. Arctic Spas® are built to last using the same construction concepts and practices as building a home.

4. Is site preparation a hassle and expensive?

There can be work involved and expenses incurred in preparing where you would like to place your tub. Arctic Spas® Forever Floor helps dramatically reduce your cash investment, all you need is a level surface.

Does not apply to AWP and CORE Series

5. What are the Myths of Salt Water Systems?

That saltwater systems are corrosive, hard on your components to maintain.

Truth: Salt water systems are not corrosive, are not hard on your components, they are easy systems to maintain and are great for your skin. Ask your dealer for more details about Spa Boy® exclusive to Arctic Spas®



HEALTH BENEFITS OF HOT TUBBING

Pain Relief

The buoyancy provided by water offers a great relief to those who suffer from chronic or injury-related skeletal discomfort. Chronic back pain can be relieved by removing the full load of gravity from the spinal column while immersed in warm water and increases activation of “feel good” neurotransmitters. This effect can be magnified by the massaging action of water jets and by ergonomic seating.

Natural Detoxification

Let's face it – hot tubs are hot. As our bodies attempt to maintain a steady internal temperature, our natural coolant, perspiration, flushes out many of the toxins and other undesirable compounds that we accumulate. In the face of an increasingly sedentary lifestyle, natural detoxification is at a premium.

Relaxation

Science aside, the most important benefit of time in a hot tub is the state of relaxation that's a part of every soak. In a world where stress accumulates easily on us all, an Arctic Spa hot tub is a respite from the storm. We can recharge our mental batteries, and emerge from the water rejuvenated.



FAMILY, FRIENDS & FUN

Hub of Family Fun.

There is no better place to spend leisure time with friends and family than in an Arctic Spa. Laughing, chatting, listening and sharing these were the family interactions that once were a daily ritual of the family dinner table. Today, we are pulled in so many different directions; we are asked for more time at work, at school, even at play. Your Arctic Spa can be your new meeting place - reconnect with your children, your spouse and yourself.

From our earliest memories, we are drawn to water, children and water are a natural combination! Add warmth and water movement and hot tubbing becomes the stuff of lifetime memories. Our beautiful LED lighting and water features will give those curious and playful minds a healthy outlet, and will build an appreciation for taking time for relaxation. As a matter of fact, time in the hot tub brings out the kid in us all, and who couldn't do with a little more fun? Smiles and laughter are standard features on every Arctic Spa.



ENVIRONMENTALLY SOUND ENERGY EFFICIENT

We Share this Planet.

Leaving a smaller environmental impact is not a destination but an ongoing journey and Arctic Spas® is committed to constantly making steps that further this cause. At the heart of our strategy is the reduced environmental impact of each of our hot tubs as it operates year after year in your backyard. By using less electrical energy everyday, in every backyard, we strive to provide not only a reduced environmental footprint, but an economic benefit for our customers.

Arctic Spas® is invested in the communities where we maintain facilities. Our World Headquarters in Thorsby, Alberta, Canada is the primary employer in the area, and we contribute to programs that foster healthy, active, and environmentally sound lifestyles within this community. Our operations in Washington State, USA strive to do the same, participating in many events, festivals and programs that put the environment first. We hope that as you strive to make better choices for our planet, you support our efforts through your purchase. Thank you.





**PROUDLY MANUFACTURED IN CANADA & THE U.S.
SOLD WORLDWIDE**

Hand Built meets High Tech

A visit to any of our production facilities will showcase the best of both worlds. Precision cutting water-jet robots work methodically in our shell construction area while craftsmen hand-assemble our beautiful western red cedar cabinets. These components are combined in a blend of technology and touch, making the Arctic Spa truly unique, possibly even the most prized possession in your backyard!

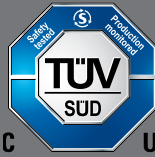

**North American Certificate
U8 17.05.56165.056**



**European Certificate
Z1.17.08.56165.057**

As an international hot tub manufacturer, we are required by law to meet certain quality and safety standards. We choose to get our certification from TÜV, one of the most strict and respected manufacturing certification organizations in the world. Beware if your hot tub is not certified by a respected agency to meet UL 1563 (USA), CSA C22.2 #218 (Canada), and IEC 60335-1/IEC 60335-2-60 (Europe).



Certified Manufacturer, Industry Leader.

Arctic Spas® is an original member in good standing as a certified Hottubstar manufacturer. As Canada's largest hot tub company Arctic Spas® is committed to being a leader in pursuing tougher energy use legislation and will continue to drive the agenda of manufacturing responsible, safe and efficient products, and honesty in advertising.

**HOT TUBS AND ALL WEATHER POOLS
ENGINEERED FOR THE WORLD'S HARSHTEST CLIMATES**



ARCTIC SPAS® CUSTOMIZATION

With endless options, we will build your spa your way.

With most manufacturers, you are often sold a spa with very little choice – as is, take it or leave it, and often it's the spa that's best for the dealer, not for you. At Arctic Spas®, you choose what's best for you!

With good advice from your local authorized Arctic Spa dealer, you never have to buy more than what you want, and never have to settle for less. From our Core Series to the cutting edge Custom Series, Arctic Spas® is all about choice.



WITH OVER **2.4 MILLION** COMBINATIONS

Including mould design, jetting configurations, purification, filtration and endless options such as our LED lighting systems and audio systems, we take your specs, your needs, your wants, all your choices and build your perfect spa.



ARCTIC SPAS® MILESTONES

AR

MANY OF THESE FEATURES AND MILESTONES ARE SHOWCASED HERE:



First heat recovery system in an acrylic spa.
First spa with a fully supporting and enclosed base.



First spa to use an "out of water" heater element.



Forever Floor®
First built-in weatherproof spa foundation.



Castcore®
First cover insert formed in mould.
First rotary-axis jets.



First spa to offer high density SMC-Moulded floor.
First to meet Ipx5 standards on all jet pumps.

1994

1998

2001

2003

2005

2007

2009

1997

1999

2002

2004

2006

2008

2010

2011



First spa depth filter.
Mylovac®
First metalized barrier, vacuum -sealed cover.



Arctic Chiller™
First solid state water cooling system.
Sonic Massage™
First vibro- acoustic massage in spas.



First spa to incorporate LED multi-colour lighting.
Legend Series First 3 jet pump spa.

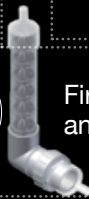

First ozone system to incorporate static mixing and off-gas destruct.



Onzen™
First proprietary and integrated salt & ozone water treatment system.



Reflex Torsion Hose™
First spa to use external sleeve flexible hose.

ARCTIC SPAS® IS ON A MISSION, FOR YOU

We believe that the better you feel, the less you have to do, and the easier it is to own an Arctic Spa, the happier you will be.

We are continually developing and introducing new features with this mission in mind.



 **Heatlock®**
First integrated spa insulation system.
 **Imagine - It™**
First custom graphic cabinets.

 **Spa Boy®**
First internet connected automated pH/sanitizer measurement and control.

 **Ultimate Lighting**
First externally mounted LED jet lighting with looped power supply.

 **AI Integration**
First voice controlled hot tub using Amazon Alexa™.

 Introduced the First All-Weather Pool in the industry.



 **Web Connect**
First internet connected & controlled hot tub.

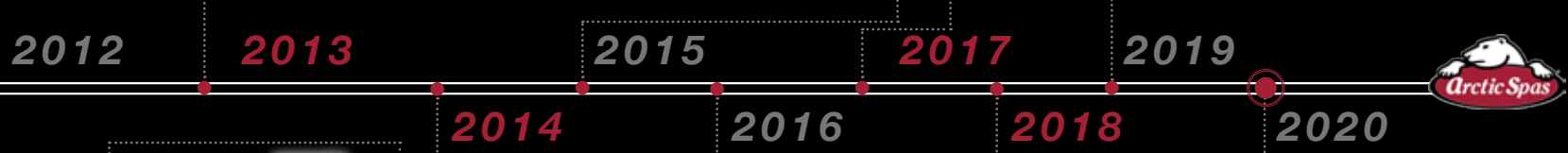

 **Cellular Modem**
Cellular connection to monitor your hot tub.

 Built first spa that can be controlled from a phone with a smartphone app.
First off-peak energy use programming introduced.

 **Smart Filter**
First web connected filtration system.



 **Pulse™ Jets**
First Titanium jet spinning mechanism.





 **Titanium Heater**
Built for extended heater longevity.



 **myarcticspa.com Web Portal**
First ever live-monitoring of spa operating conditions, including automated water care parameters, viewable from any web-connected device.



 **Electrical Consumption Monitoring**
First Built In Real Time.







CUSTOM SERIES

UNCOMPROMISED EXCELLENCE

*Unsurpassed Comfort, Construction and Technology
completely custom built to your needs*



MODELS:

- Summit XL
- Summit
- Tundra
- Kodiak
- Klondiker

- Frontier
- Yukon
- Cub
- Arctic Fox

CUSTOM SERIES

SUMMIT XL

 X9

V: 2033 litres | 537 US gallons
W: 235 cm | 93" H: 98 cm | 39" L: 297 cm | 117"

SDS

Jets 60 Pumps 4



LEGEND SELECT

Jets 60
Pumps 3



LEGEND / SIGNATURE

Jets 40
Pumps 3/2



PRESTIGE

Jets 20
Pumps 1

This is the biggest hot tub in our line up!

We have taken our most popular hot tub and literally stretched it out. Now you can pack more people in when the whole family wants to soak or when it's party time. The shuttle seats are exactly the same as in the Summit model, the most comfortable and popular shuttle style seats in our entire line up.

SUMMIT

 X6

V: 1363 litres | 360 US gallons
W: 235 cm | 93" H: 98 cm | 39" L: 235 cm | 93"

SDS

Jets 60 Pumps 4



LEGEND SELECT

Jets 60
Pumps 3



LEGEND / SIGNATURE

Jets 40
Pumps 3/2



PRESTIGE

Jets 20
Pumps 1

The Summit might be the perfect family spa.

This spa features three different depth shuttle seats for varied body types ensuring you will find both amazing comfort and depth. Multi level armrests and a swivel/lounge seat offer great variety in what has always been our most popular model.

CUSTOM SERIES

TUNDRA



V: 1556 litres | 411 US gallons
 W: 235 cm | 93" H: 98 cm | 39" L: 235 cm | 93"

SDS

Jets 60 Pumps 4



LEGEND SELECT

Jets 60
Pumps 3



LEGEND / SIGNATURE

Jets 40
Pumps 3/2



PRESTIGE

Jets 20
Pumps 1

Maybe the best combination of comfort and capacity to be found anywhere.

We've managed to fit in four of our amazing shuttle seats, three more multi-level seats and still keep a massive footwell. If you are looking for serious comfort but still room for family and friends then the **Tundra** may be the tub for you.

KODIAK



V: 1295 litres | 342 US gallons
 W: 235 cm | 93" H: 98 cm | 39" L: 235 cm | 93"

SDS

Jets 60 Pumps 4



LEGEND SELECT

Jets 60
Pumps 3



LEGEND / SIGNATURE

Jets 40
Pumps 3/2



PRESTIGE

Jets 20
Pumps 1

The Kodiak has all the benefits and features of the Cub only bigger!

The lounge is modelled after the famous gravity chair to prevent sliding and floating. The **Kodiak** now features His and Hers shuttle seats so there's no more fighting for the most comfortable seats in the house.

CUSTOM SERIES

KLONDIKER

 X5

V: 1412 litres | 373 US gallons
W: 235 cm | 93" H: 98 cm | 39" L: 235 cm | 93"

SDS

Jets 60 Pumps 4



LEGEND SELECT

Jets 60
Pumps 3



LEGEND / SIGNATURE

Jets 40
Pumps 3/2



PRESTIGE

Jets 20
Pumps 1

Luxurious lounging is the name of the game in this tub featuring our His and Hers no float loungers. Recently redesigned the new loungers, may be as comfortable as you will find anywhere. Three individualized sculptured seats and multi-level armrests finish off this amazing model.

FRONTIER

 X5

V: 1268 litres | 335 US gallons
W: 217 cm | 85" H: 98 cm | 39" L: 235 cm | 93"

SDS

Jets 40 Pumps 3



LEGEND

Jets 40
Pumps 3



SIGNATURE

Jets 40
Pumps 2



PRESTIGE

Jets 20
Pumps 1

Looking for a tub with the ultimate comfort for four, then look no further than the Frontier. This very unique design features His and Hers shuttle seats and mini loungers. Our only 7' x 8' spa can fit into a smaller area than our 8' models.

CUSTOM SERIES

YUKON

 X6

V: 1264 litres | 334 US gallons
W: 217 cm | 85" H: 104 cm | 41" L: 217 cm | 85"

SDS

Jets 40 ● Pumps 3



LEGEND

Jets 40
Pumps 3



SIGNATURE

Jets 40
Pumps 2



PRESTIGE

Jets 20
Pumps 1

Space and comfort abound in this spa with one of the largest 7' footwells in the industry. Now featuring His and Hers shuttle seats and two corner bucket seats with bench seating provide a great combination of comfort and capacity for any family.

CUB

 X4

V: 1041 litres | 275 US gallons
W: 217 cm | 85" H: 104 cm | 41" L: 217 cm | 85"

SDS

Jets 40 ● Pumps 3



LEGEND

Jets 40
Pumps 3



SIGNATURE

Jets 40
Pumps 2



PRESTIGE

Jets 20
Pumps 1

His and Hers shuttle seats and a gravity chair designed lounger makes the Cub highly sought after model. Enjoy the multi-level armrests in both shuttle seats or stretch out in the lounger. Either way, comfort awaits.

CUSTOM SERIES

ARCTIC FOX



V: 787 litres | 208 US gallons
W: 174 cm | 69" H: 98 cm | 39" L: 217 cm | 85"

SIGNATURE

Jets 30 Pumps 2



PRESTIGE

Jets 15
Pumps 1

Our Design team finally figured out how to get our most comfortable seats into our smallest Custom Series spa. His and Hers shuttle seats and an amazing lounger are featured in this comfortable yet compact and deep design.



FEATURES LINEUP

Specifications	Summit XL	Summit	Tundra	Kodiak	Klondiker	Frontier	Yukon	CUB	Arctic Fox
Dimensions (ft)	8 x 10	8 x 8	8 x 8	8 x 8	8 x 8	7 x 8	7 x 7	7 x 7	5 x 7
Dimensions (cm)	235 x 297	235 x 235	235 x 235	235 x 235	235 x 235	217 x 235	217 x 217	217 x 217	174 x 217
Water Capacity (gal)	537	360	411	342	373	335	334	275	208
Water Capacity (lts)	2033	1363	1556	1295	1412	1268	1264	1041	787
Weight (lbs)	1057	935	951	973	944	785	735	741	611
Weight (kg)	479	424	431	441	428	356	333	336	277
# of Jet Pumps	4 to 1	4 to 1	4 to 1	4 to 1	4 to 1	3 to 1	3 to 1	3 to 1	2 or 1
# of Jets	60-40-20	60-40-20	60-40-20	60-40-20	60-40-20	40-20	40-20	40-20	30-15
Size of Jets	3" / 5" / 7"	3" / 5" / 7"	3" / 5" / 7"	3" / 5" / 7"	3" / 5" / 7"	3" / 5" / 7"	3" / 5" / 7"	3" / 5" / 7"	3" / 5"
# of Seats/Lounger	9 / 0	6 / 0	7 / 0	4 / 1	3 / 2	3 / 2	6 / 0	3 / 1	2 / 1
Capacity	9	7	7	6	6	5	6	5	4
Standard Features									
Elastocast Shell									
Composite Shell	•	•	•	•	•	•	•	•	•
Heatlock®									
Freeheat™	•	•	•	•	•	•	•	•	•
Insulated Platform									
Everlast Floor									
Forever Floor	•	•	•	•	•	•	•	•	•
Mylovac Cover (5" - 4")	•	•	•	•	•	•	•	•	•
Cover (5" - 4")									
Cover (4" - 2")									
Western Red Cedar Cabinet	•	•	•	•	•	•	•	•	•
Core No-Maintenance Cabinet									
Total Access	•	•	•	•	•	•	•	•	•
Gecko Control System									
EcoPAK Spa Control System	•	•	•	•	•	•	•	•	•
OnSpa®	•	•	•	•	•	•	•	•	•
Flow-Through Heater									
Titanium Remote Heater	•	•	•	•	•	•	•	•	•
High Efficiency Aquaflow Pumps	•	•	•	•	•	•	•	•	•
High Efficiency Pumps									
Activeskim Filtration (Single)									
Activeskim Filtration (Dual)									
Progressive "Smart" Filtration	•	•	•	•	•	•	•	•	•
Low Profile SS Ripple Jets	•	•	•	•	•	•	•	•	•
SS Pepperleaf Jets									
Black Pepperleaf Pulse™ Jets									
Northern LED Lights	•	•	•	•	•	•	•	•	•
Safety Approvals	•	•	•	•	•	•	•	•	•
Reflex Torsion	•	•	•	•	•	•	•	•	•
Comfort and Hydro-Massage	•	•	•	•	•	•	•	•	•
Adjustable Headrests	•	•	•	•	•	•	•	•	•
Core Adjustable Headrests									
Warranty on Parts	5 Years	5 Years	5 Years	5 Years	5 Years	5 Years	5 Years	5 Years	5 Years
Warranty on Labour	5 Years	5 Years	5 Years	5 Years	5 Years	5 Years	5 Years	5 Years	5 Years
Colour Choice	2	8	8	8	8	8	8	8	8
Arctic Pure Water Care	•	•	•	•	•	•	•	•	•
Water Feature	•	•	•	•	•	•	•	•	•
Optional Features									
Forever Floor	Included	Included	Included	Included	Included	Included	Included	Included	Included
Mylovac Cover (5" - 4")-Weathershield	•	•	•	•	•	•	•	•	•
Mylovac Cover (5" - 4")	Included	Included	Included	Included	Included	Included	Included	Included	Included
Cover (5" - 4")									
No Maintenance Cabinet	•	•	•	•	•	•	•	•	•
Peak Ozone System	•	•	•	•	•	•	•	•	•
Onzen™ Salt Water System	•	•	•	•	•	•	•	•	•
Spa Boy®	•	•	•	•	•	•	•	•	•
WetTunes™									
AquaTremor	•	•	•	•	•	•	•	•	•
Sound FX									
Family Lighting Package	•	•	•	•	•	•	•	•	•
Ultimate Lighting Package	•	•	•	•	•	•	•	•	•
Corner Accent Lighting	•	•	•	•	•	•	•	•	•
Skyfall Fogger	•	•	•	•	•	•	•	•	•
In.Touch 2	OnSpa Included	OnSpa Included	OnSpa Included	OnSpa Included	OnSpa Included	OnSpa Included	OnSpa Included	OnSpa Included	OnSpa Included
SS Pepperleaf Pulse™ Jets	Included	Included	Included	Included	Included	Included	Included	Included	Included
YESS Oxygen Therapy	•	•	•	•	•	•	•	•	•
Plug & Play									
Aquanova									
SDS	•	•	•	•	•	•	•	•	

FEATURES



DIAGRAM CUSTOM SERIES



Waterfall



Adjustable Headrests



Stainless Steel Jet



Comfort and Hydro-Massage



Composite Shell



FreeHeat™



Pressure Control



High Efficiency Aquaflow Pumps



Reflex Torsion



Forever Floor



Northern LED Lights



EcoPAK Spa Control System

FEATURES



Mylovac Cover (5" - 4")



Total Access



Safety Approvals



Western Red Cedar Cabinet

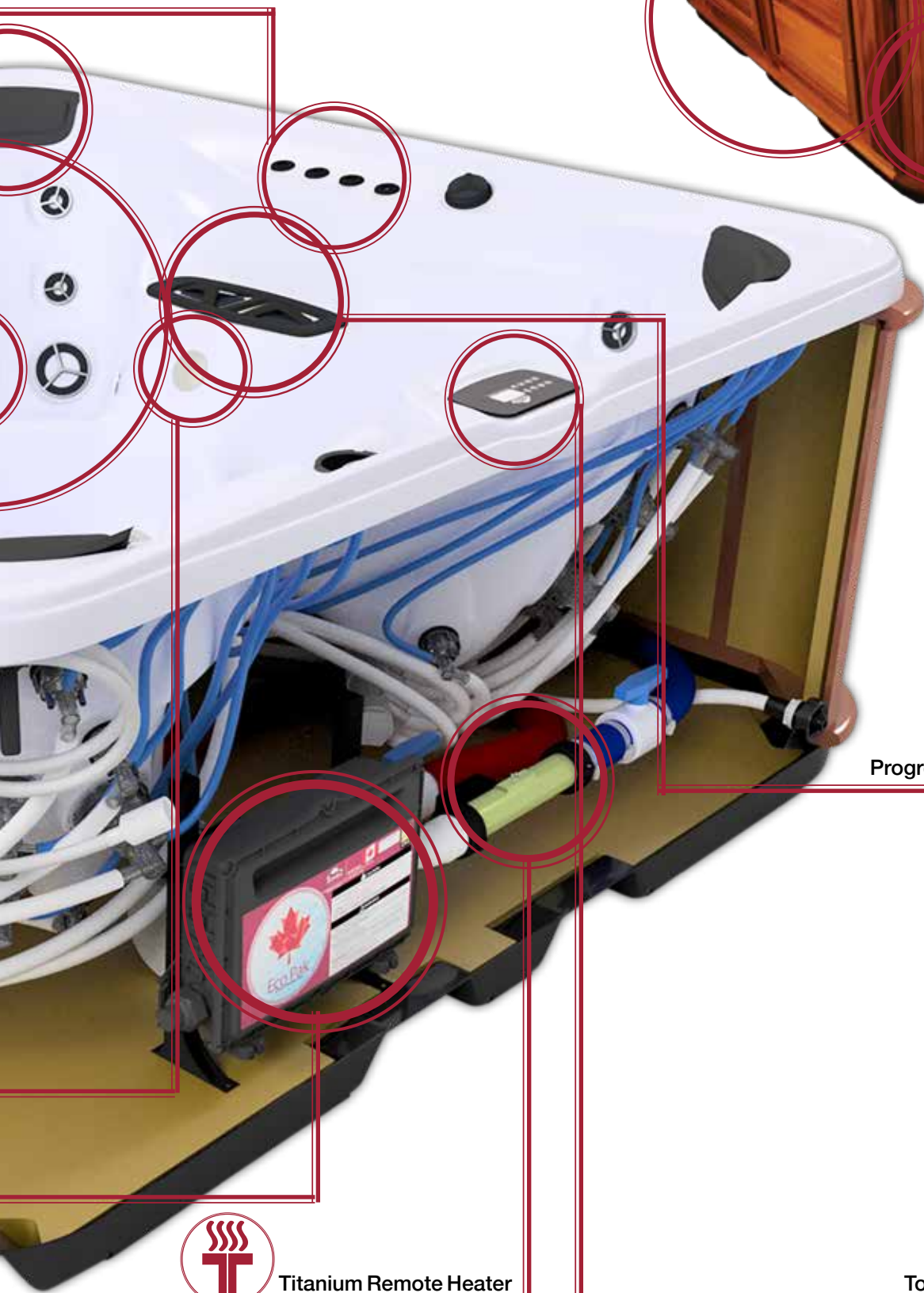

Progressive "Smart" Filtration



Pro Filter



Titanium Remote Heater



Topside Control





CLASSIC SERIES

CLASSIC ARCTIC ENGINEERING

25 years of Engineering Excellence built into every Classic Series



MODELS:

- Mustang
- McKinley
- Totem
- Eagle
- Timberwolf

CLASSIC SERIES

MUSTANG

 X5

V: 1400 litres | 370 US gallons
W: 235 cm | 93" H: 98 cm | 39" L: 235 cm | 93"

SIGNATURE

Jets 40 ● Pumps 2



PRESTIGE

Jets 20
Pumps 1

We proudly present The Mustang!

Featuring smoother lines and even better ergonomics. Relax in the spacious lounge or lean back with an invigorating massage in a fantastic therapy seat. Big enough for the family, luxury for all.

MCKINLEY

 X7

V: 1700 litres | 449 US gallons
W: 235 cm | 93" H: 98 cm | 39" L: 235 cm | 93"

SIGNATURE

Jets 40 ● Pumps 2



PRESTIGE

Jets 20
Pumps 1

Individualized seating, in an open concept spa?

The McKinley's award-winning design makes this possible. Four corner captain's seats anchor a total of seven seating positions, which surrounds a huge footwell area. Built for a crowd, but still offering creature comforts for the individual, the McKinley is the perfect choice for a large family or frequent entertaining.

CLASSIC SERIES

TOTEM

 X6

V: 1360 litres | 360 US gallons
W: 217 cm | 85" H: 104 cm | 41" L: 217 cm | 85"

SIGNATURE

Jets 40 ● Pumps 2



PRESTIGE

Jets 20
Pumps 1

The Totem is another great family-oriented offering that provides both space and comfort. Its circular design allows one of the largest 7' foot wells in the industry. Three dedicated therapy areas as well as a multi-level bench area ensure that everyone can find a favourite spot.

EAGLE

 X5

V: 1185 litres | 313 US gallons
W: 217 cm | 85" H: 104 cm | 41" L: 217 cm | 85"

SIGNATURE

Jets 40 ● Pumps 2



PRESTIGE

Jets 20
Pumps 1

One of the most versatile designs in our line up.

The Eagle offers a finely sculpted therapy seat, a roomy lounge and a corner nook for a couple more friends. With this diverse selection of seating styles, everyone can find a favourite.

CLASSIC SERIES

TIMBERWOLF



V: 884 litres | 234 US gallons
W: 174 cm | 69" H: 98 cm | 39" L: 217 cm | 86"

SIGNATURE

Jets 30 Pumps 2



PRESTIGE

Jets 15
Pumps 1

The Timberwolf is an extremely comfortable spa with a small footprint. It features two lounge seats for maximum therapy and room for two more if needed. Perfect for extreme comfort in a smaller size.



FEATURES LINEUP

Specifications	Mustang	McKinley	Totem	Eagle	Timberwolf
Dimensions (ft)	8 x 8	8 x 8	7 x 7	7 x 7	5 x 7
Dimensions (cm)	235 x 235	235 x 235	217 x 217	217 x 217	174 x 217
Water Capacity (gal)	370	449	360	313	234
Water Capacity (lts)	1400	1700	1360	1185	884
Weight (lbs)	973	951	735	741	611
Weight (kg)	441	431	333	336	277
# of Jet Pumps	2 or 1	2 or 1	2 or 1	2 or 1	2 or 1
# of Jets	40 - 20	40 - 20	40 - 20	40 - 20	30 - 15
Size of Jets	3" / 5"	3" / 5"	3" / 5"	3" / 5"	3" / 5"
# of Seats/Lounger	4 / 1	7 / 0	6 / 0	4 / 1	1 / 2
Capacity	6	7	7	6	3
Standard Features					
Elastocast Shell					
Composite Shell	●	●	●	●	●
Heatlock®					
Freeheat™	●	●	●	●	●
Insulated Platform	●	●	●	●	●
Everlast Floor					
Forever Floor					
Mylovac Cover (5" - 4")					
Cover (5" - 4")	●	●	●	●	●
Cover (4" - 2")					
Western Red Cedar Cabinet	●	●	●	●	●
Core No-Maintenance Cabinet					
Total Access	●	●	●	●	●
Gecko Control System	●	●	●	●	●
EcoPAK Spa Control System					
OnSpa®					
Flow-Through Heater	●	●	●	●	●
Titanium Remote Heater					
High Efficiency Aquaflow Pumps					
High Efficiency Pumps	●	●	●	●	●
Activeskim Filtration (Single)					
Activeskim Filtration (Dual)	●	●	●	●	●
Progressive "Smart" Filtration					
Low Profile SS Ripple Jets					
SS Pepperleaf Jets	●	●	●	●	●
Black Pepperleaf Pulse™ Jets					
Northern LED Lights	●	●	●	●	●
Safety Approvals	●	●	●	●	●
Reflex Torsion	●	●	●	●	●
Comfort and Hydro-Massage	●	●	●	●	●
Adjustable Headrests	●	●	●	●	●
Core Adjustable Headrests					
Warranty on Parts	3 Years	3 Years	3 Years	3 Years	3 Years
Warranty on Labour	3 Years	3 Years	3 Years	3 Years	3 Years
Colour Choice	8	8	8	8	8
Arctic Pure Water Care	●	●	●	●	●
Water Feature	●	●	●	●	●
Optional Features					
Forever Floor	●	●	●	●	●
Mylovac Cover (5" - 4")-Weathershield					
Mylovac Cover (5" - 4")	●	●	●	●	●
Cover (5" - 4")	Included	Included	Included	Included	Included
No Maintenance Cabinet	●	●	●	●	●
Peak Ozone System	●	●	●	●	●
Onzen™ Salt Water System	●	●	●	●	●
Spa Boy®					
WetTunes™	●	●	●	●	●
AquaTremor					
Sound FX					
Family Lighting Package	●	●	●	●	●
Ultimate Lighting Package					
Corner Accent Lighting					
Skyfall Fogger					
In.Touch 2	●	●	●	●	●
SS Pepperleaf Pulse™ Jets	Included	Included	Included	Included	Included
YESS Oxygen Therapy					
Plug & Play	●	●	●	●	●
Aquanova					
SDS					

FEATURES



DIAGRAM CLASSIC SERIES



Waterfall



Adjustable Headrests



Pulse Jets



Comfort and Hydro-Massage



Composite Shell



FreeHeat™



Northern LED Lights



Reflex Torsion



Insulated Platform



High Efficiency Pumps

FEATURES



Cover (5" - 4")



Total Access



Safety Approvals



Western Red Cedar Cabinet



Activeskim Filtration (Dual)



Silver Sentinel 1 Micron Filters

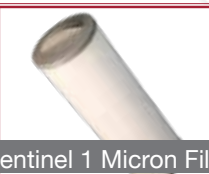

Microfiber Filters



Compact Pleated Filter



Gecko Control System



Flow-Through Heater



Topside Control







CORE SERIES

OUR CORE VALUES

The foundation of our construction techniques built into every spa to fit nearly any budget

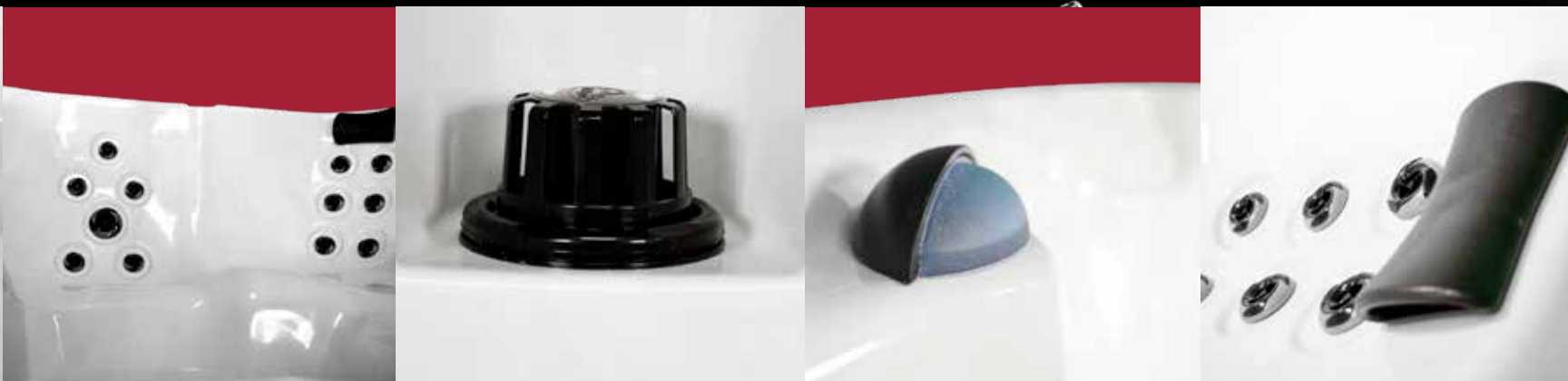

MODELS:

- Grizzly
- Orca
- Aurora
- Husky
- Ellesmere
- Otter

CORE SERIES

GRIZZLY

 X5

V: 1420 litres | 375 US gallons
W: 231 cm | 91" H: 99 cm | 39" L: 231 cm | 91"

Jets 40 Pumps 2



The **Grizzly** model has room for six and features a lounge seat, two captain's seats and bench seating for three more. This model is a very good combination of size, comfort and therapy.

ORCA

 X6

V: 1514 litres | 400 US gallons
W: 231 cm | 91" H: 99 cm | 39" L: 231 cm | 91"

Jets 40 Pumps 2



The **Orca** is a very nice mid sized spa with an open seating plan and room for seven with a spacious footwell area. An excellent choice for large families.

CORE SERIES

AURORA

 X6

V: 1193 litres | 315 US gallons
W: 206 cm | 81" H: 99 cm | 39" L: 204 cm | 80"

Jets 20 ● Pumps 1 ● (4HP 220V)



The **Aurora** is a feature rich family spa with seating up to six. Featuring ergonomic seating design with variation of depth and width, the **Aurora's** seating layout surrounds a spacious footwell. The **Aurora** is equipped with modern, top skimming filtration and twenty therapeutic jets provide high quality massage and fun.

HUSKY

 X5

V: 1030 litres | 272 US gallons
W: 186 cm | 73" H: 99 cm | 39" L: 213 cm | 84"

Jets 20 ● Pumps 1 ●



The **Husky** has room for five, with a nice open plan and a variety of upright seating. Simple comfort and relaxation in a small footprint is what the Husky is all about.

CORE SERIES

ELLESMERE

 X3

V: 871 litres | 230 US gallons
W: 157 cm | 62" H: 99 cm | 39" L: 218 cm | 86"

Jets 20 ● Pumps 1



The **Ellesmere** has room for 3, with a nice lounge seat and 2 upright seats. It is perfect for small decks, condo owners or those who just want a reliable and simple way to get in hot water

OTTER

 X2

V: 568 litres | 150 US gallons
W: 117 cm | 46" H: 75 cm | 30" L: 218 cm | 86"

Jets 12 ● Pumps 1



The **Otter** is perfect for compact spaces or a couple choosing to spend the evening in. Extreme comfort and compact footprint are what this model is all about.

FEATURES LINEUP

Specifications	Grizzly	Orca	Aurora	Husky	Ellesmere	Otter
Dimensions (ft)	8 x 8	8 x 8	7 x 7	6 x 7	5 x 7	4 x 7
Dimensions (cm)	231 x 231	231 x 231	206 x 204	213 x 186	218 x 157	218 x 117
Water Capacity (gal)	375	400	315	272	230	150
Water Capacity (lts)	1420	1514	1193	1030	871	568
Weight (lbs)	1001	1001	702	631	560	400
Weight (kg)	454	454	318	286	254	181
# of Jet Pumps	2	2	1	1	1	1
# of Jets	40	40	20	20	20	12
Size of Jets	2.5" / 4"	2.5" / 4"	2.5" / 4"	2.5" / 4"	2.5 / 4"	2.5"
# of Seats/Lounger	4 / 1	6 / 0	6 / 0	5 / 0	2 / 1	2 / 0
Capacity	6	7	7	6	4	2
Standard Features						
Elastocast Shell	●	●	●	●	●	●
Composite Shell						
Heatlock®	●	●	●	●	●	●
Freeheat™						
Insulated Platform						
Everlast Floor	●	●	●	●	●	●
Forever Floor						
Mylovac Cover (5" - 4")						
Cover (5" - 4")						
Cover (4" - 2")	●	●	●	●	●	●
Western Red Cedar Cabinet						
Core No-Maintenance Cabinet	●	●	●	●	●	●
Total Access	●	●	●	●	●	●
Gecko Control System	●	●	●	●	●	●
EcoPAK Spa Control System						
OnSpa®						
Flow-Through Heater	●	●	●	●	●	●
Titanium Remote Heater						
High Efficiency Aquaflow Pumps						
High Efficiency Pumps						
Activeskim Filtration (Single)	●	●	●	●	●	●
Activeskim Filtration (Dual)						
Progressive "Smart" Filtration						
Low Profile SS Ripple Jets						
SS Pepperleaf Jets						
Black Pepperleaf Pulse™ Jets	●	●	●	●	●	●
Northern LED Lights	●	●	●	●	●	●
Safety Approvals	●	●	●	●	●	●
Reflex Torsion	●	●	●	●	●	●
Comfort and Hydro-Massage	●	●	●	●	●	●
Adjustable Headrests	●	●	●	●	●	●
Core Adjustable Headrests	●	●	●	●	●	●
Warranty on Parts	3 Years	3 Years	3 Years	3 Years	3 Years	3 Years
Warranty on Labour	1 Year	1 Year	1 Year	1 Year	1 Year	1 Year
Colour Choice	5	5	6	6	6	6
Arctic Pure Water Care	●	●	●	●	●	●
Water Feature	●	●	●	●	●	●
Optional Features						
Forever Floor						
Mylovac Cover (5" - 4")-Weathershield						
Mylovac Cover (5" - 4")						
Cover (5" - 4")	●	●	●	●	●	●
No Maintenance Cabinet	Included	Included	Included	Included	Included	Included
Peak Ozone System						
Onzen™ Salt Water System						
Spa Boy®						
WetTunes™						
AquaTremor						
Sound FX	●	●	●	●	●	●
Family Lighting Package	●	●	●	●	●	●
Ultimate Lighting Package						
Corner Accent Lighting						
Skyfall Fogger						
In.Touch 2	●	●	●	●	●	●
SS Pepperleaf Pulse™ Jets	●	●	●	●	●	●
YESS Oxygen Therapy						
Plug & Play			●	●	●	●
Aquanova	●	●	●	●	●	●
SDS						

FEATURES



DIAGRAM CORE SERIES



Core Adjustable Headrests



Pulse Jets



Comfort and Hydro-Massage



Elastocast Shell



Heat Lock



Gecko Control System



Flow-Through Heater



Everlast Floor



Topside Control



High Efficiency Pumps

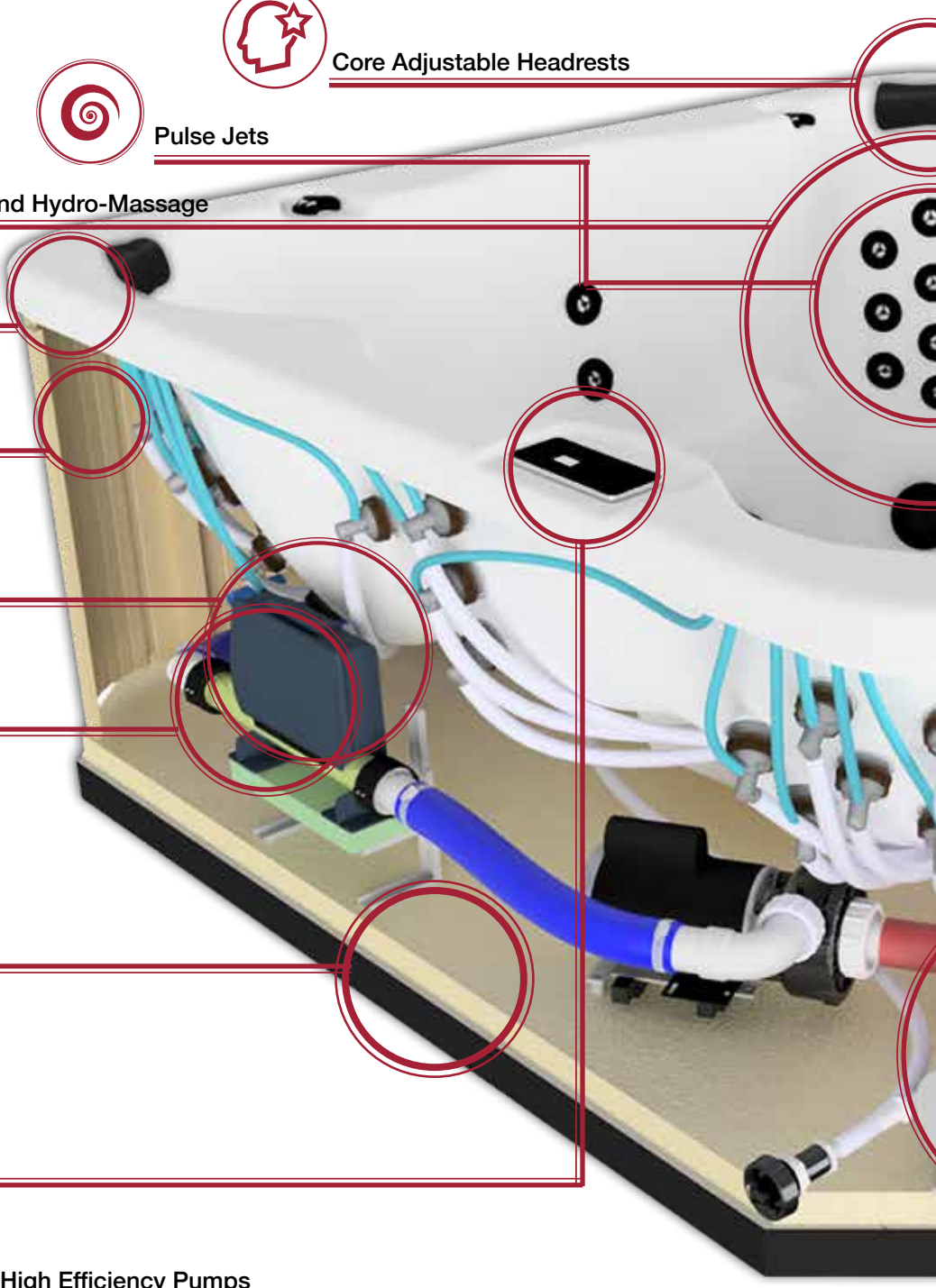

FEATURES



Cover (4" - 2")



Safety Approvals



Core No-Maintenance Cabinet



Activeskim Filtration (Single)



Silver Sentinel 1 Micron Filters

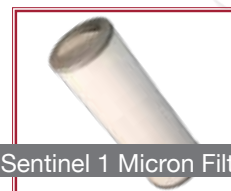

Northern LED Lights



Reflex Torsion







ALL WEATHER POOLS

THE LUXURY OF A SWIMMING POOL AND SPA IN THE COMFORT AND PRIVACY OF YOUR OWN HOME.

Our all weather pools bridge the gap between hot tub and pool. Enjoy the benefits of a pool at home, all year, in any weather, with the efficiency and low maintenance that comes with an Arctic Spa hot tub.



MODELS:

- Ocean
- Okanagan
- Wolverine
- Kingfisher
- Hudson
- Athabasca

ALL WEATHER POOL

OCEAN



V: 5100 litres | 1347 US gallons
W: 236 cm | 93" H: 129 cm | 51" L: 436 cm | 172"

SDS

Jets 60 Pumps 4



LEGEND SELECT

Jets 60
Pumps 3

LEGEND / SIGNATURE

Jets 40
Pumps 3/2

PRESTIGE

Jets 20
Pumps 1

MAXIMUM THERAPY WITH BASIC SWIMMING

The **Ocean** includes maximum luxury in the form of more swim spa features than the other All Weather Pools. The Ocean's therapeutic potential is enriched by its customizability in the form of multiple available jet configurations.

OKANAGAN



V: 5100 litres | 1347 US gallons
W: 236 cm | 93" H: 129 cm | 51" L: 436 cm | 172"

SDS

Jets 40 Pumps 3



LEGEND

Jets 40
Pumps 3

SIGNATURE

Jets 40
Pumps 2

PRESTIGE

Jets 20
Pumps 1

FANTASTIC LIGHTING + SWIMMING

We are known for making the best cold weather spas on the planet! When we travel to a tropic location, a must-have is a swim up bar! Even better, leave the hassles of travel behind, and enjoy our newest All Weather Pool, the **Okanagan**. Fittingly named for Canada's summer playground, the Okanagan comes complete with an LED-lit swim up bar and even an ice bucket to keep the drinks cold when the heat is on! Fantastic lighting throughout, water features and a choice of swim jets to play in, this All Weather Pool can really do it all.

ALL WEATHER POOL

WOLVERINE



V: 5100 litres | 1347 US gallons
W: 236 cm | 93" H: 129 cm | 51" L: 436 cm | 172"

Jets 26 ● Pumps 3



THE ULTIMATE HYBRID: ADVANCED SWIMMING AND MAXIMUM THERAPY
The **Wolverine** is uncompromising in every way. With both a full-length swim zone and two therapy seats, it is a perfect blend of performance and therapy. Both, the Niagara Counter Current Swim System and the maximum number of therapeutic jets, possible solidify the Wolverine as the best All Weather Pool available.

KINGFISHER

V: 5100 litres | 1347 US gallons
W: 236 cm | 93" H: 129 cm | 51" L: 436 cm | 172"

Jets 3 ● Pumps 2



MORE SWIMMING, MORE SPACIOUS
For the user in need of unobstructed space for fitness, the **Kingfisher** features the longest and widest swim zone with stairs only on the left-hand side for inconspicuous access. As with any All Weather Pool, the Niagara Counter Current Swim System includes lighting to assist users' alignment while swimming in turbulent conditions.

ALL WEATHER POOL

HUDSON



V: 5100 litres | 1347 US gallons
W: 236 cm | 93" H: 129 cm | 51" L: 436 cm | 172"

Jets 26 ● Pumps 3



INTERMEDIATE SWIMMING AND THERAPY/COMFORT

The **Hudson** offers an entry level resistance swim system in the form of the Monsoon Counter Current Swim System and two therapy seats. The Monsoon System can be used in conjunction with the Tether Resistance Swim System to serve multiple levels of fitness in addition to climate-defying family fun.

ATHABASCAN



V: 5100 litres | 1347 US gallons
W: 236 cm | 93" H: 129 cm | 51" L: 436 cm | 172"

Jets 1 ● Pumps 1



OUR MOST SPACIOUS POOL

The **Athabaskan** is the purest representation of the All Weather Pool. With the largest open water area in the All Weather Pool range, the Athabaskan provides the maximum amount of room for relaxation and fun. Movement in and out of the pool is facilitated by the simple moulded steps, and a slightly elevated area at the front of the tub gives little ones a break from deep-water activities. The Athabaskan is the family backyard pool that is available year round - always the perfect temperature and just steps from your home.

CHART

Specifications	Ocean	Okanagan	Hudson	Wolverine	Kingfisher	Athabasca
Dimensions (ft)	8 x 14	8 x 14	8 x 14	8 x 14	8 x 14	8 x 14
Dimensions (cm)	236 x 436	236 x 436	236 x 436	236 x 436	236 x 436	236 x 436
Water Capacity (gal)	1347	1347	1347	1347	1347	1347
Water Capacity (lts)	5100	5100	5100	5100	5100	5100
Weight (lbs)	1910	1910	1910	1910	1910	1910
Weight (kg)	866	866	866	866	866	866
# of Jet Pumps	4 to 1	3 to 1	3	3	2	1
# of Jets	60 - 40 - 20	40 - 20	26	26	3	2
Size of Jets	3" / 5" / 7"	3" / 5" / 7"	3" / 5" / 7"	3" / 5" / 7"	7"	7"
# of Seats/Lounger	6 / 0	4 / 0	4 / 2	2 / 2	0 / 0	2 / 0
Capacity	12	12	12	12	12	12
Standard Features						
Composite Shell	●	●	●	●	●	●
Freeheat™	●	●	●	●	●	●
Insulated Platform			●	●	●	●
Forever Floor	●	●				
Cover (5" - 4")			●	●	●	●
Mylovac Cover	●	●				
Western Red Cedar Cabinet with Total Access™	●	●	●	●	●	●
Gecko Control System			●	●	●	●
EcoPAK Spa Control System	●	●				
OnSpa®	●	●				
Flow-Through Heater			●	●	●	●
Titanium Remote Heater	●	●				
High Efficiency Aquaflo Pumps	●	●				
High Efficiency Pumps			●	●	●	●
Activeskim Filtration (Dual)			●	●	●	●
Progressive "Smart" Filtration	●	●				
Low Profile SS Ripple Jets	●	●				
SS Pepperleaf Jets			●	●	●	●
Northern Lights	●	●	●	●	●	●
Safety Approvals	●	●	●	●	●	●
Reflex Torsion	●	●	●	●	●	●
Comfort and Hydro-Massage	●	●	●	●	●	●
Adjustable Headrests	●	●	●	●	●	●
Warranty on Parts	5 Years	5 Years	3 Years	3 Years	3 Years	3 Years
Warranty on Labour	5 Years	5 Years	3 Years	3 Years	3 Years	3 Years
Arctic Pure Water Care	●	●	●	●	●	●
Water Feature	●	●	●	●	●	●
Niagara System				●	●	
Tether System	●	●	●	●	●	●
Monsoon System	●	●	●			
Optional Features						
Forever Floor	Included	Included	●	●	●	●
Mylovac Cover (5" - 4") - Weathershield	●	●				
Mylovac Cover (5" - 4")	Included	Included	●	●	●	●
Cover (5" - 4")			Included	Included	Included	Included
No Maintenance Cabinet	●	●	●	●	●	●
Peak Ozone System	●	●	●	●	●	●
Onzen™ Salt Water System	●	●	●	●	●	●
Spa Boy®	●	●				
WetTunes™			●	●	●	●
AquaTremor	●	●				
Family Lighting	●	●	●	●	●	●
Ultimate Lighting	●	●				
Corner Accent Lighting	●	●				
Skyfall Fogger	●					
In.Touch 2			●	●	●	●
SS Pepperleaf Pulse™ Jets			Included	Included	Included	Included
YESS Oxygen Therapy	●	●				
SDS	●	●				
Rowing / Fitness Kit	●	●				

*** PLEASE NOTE: THAT SITE PREPARATION IS REQUIRED FOR ALL WEATHER POOL INSTALLATION ***

FEATURES



DIAGRAM ALL WEATHER POOL



Adjustable Headrests



Comfort and Hydro-Massage



Pulse Jets



Composite Shell



Pressure Control



FreeHeat™



High Efficiency Aquaflow Pumps



Forever Floor



Reflex Torsion

FEATURES



Cover (5" - 4")



Total Access



Topside Control



Safety Approvals



Western Red Cedar Cabinet

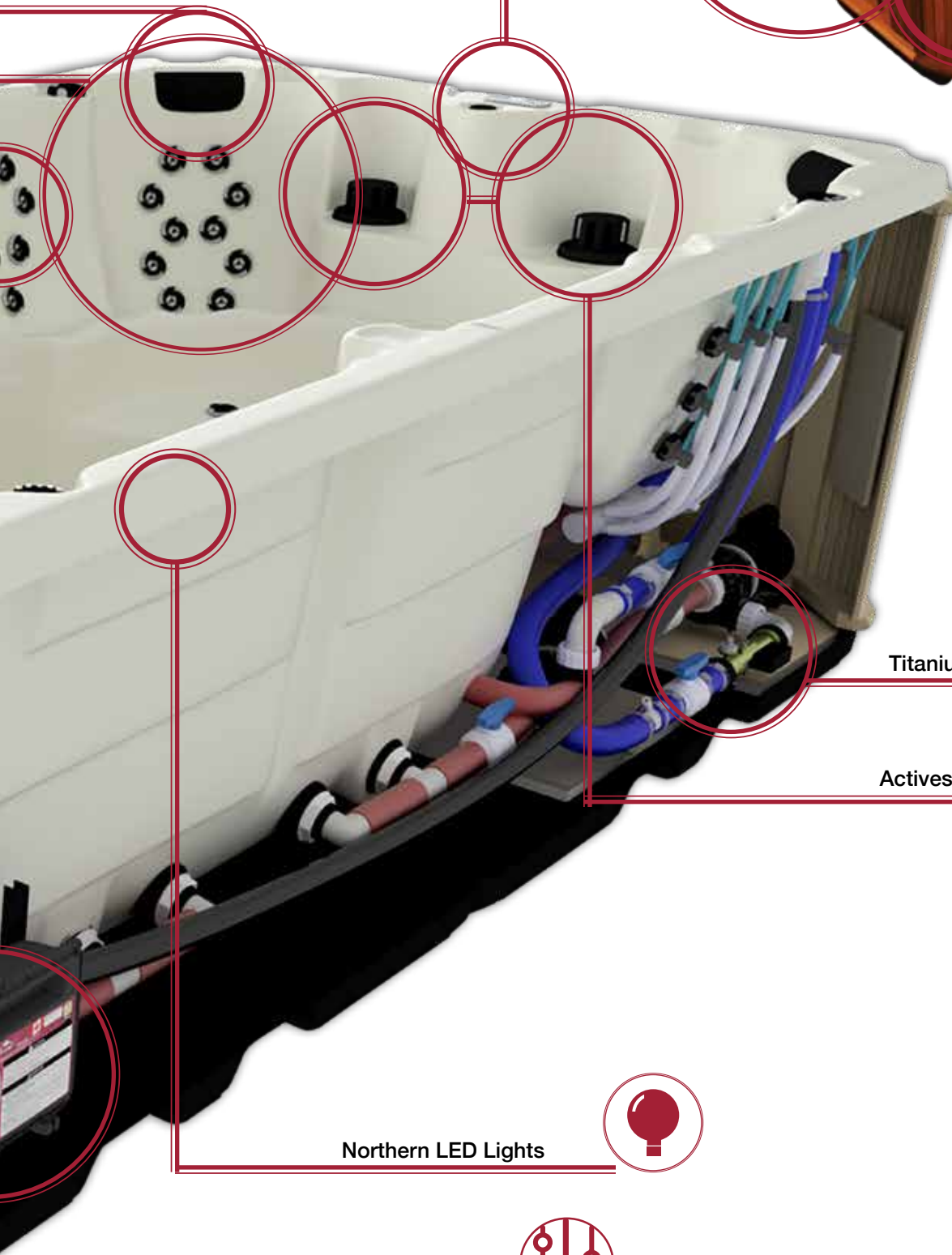

Titanium Remote Heater



Activeskim Filtration (Dual)



Silver Sentinel 1 Micron Filters

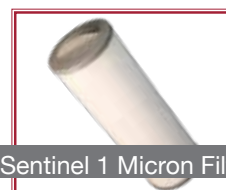

Microfiber Filters



Compact Pleated Filter



Northern LED Lights



EcoPAK Spa Control System





BUCKLE UP AND HOLD ON!

We've raised the standard again with our SDS massage chair. Our R&D department designed and built a new 7" bearingless massage jet specifically for this seat. We've dedicated a high flow pump to this chair and seven high flow pulsating jets to complete what may be the most amazing massage chair in the industry. Sit back, hold on and enjoy.



OCEAN

OUR VERY BEST



OKANAGAN



SUMMIT XL



SUMMIT



YUKON



TUNDRA



KODIAK





FEATURES

ENGINEERED FOR THE WORLD'S HARSHTEST CLIMATES





SELF-SUPPORTING COMPOSITE HULL

Guaranteed to Last a Lifetime

The shell of an Arctic Spa is undoubtedly the core of our design, and as such, is uniquely designed to handle this function.

We begin by vac-forming sheets of premium Aristech® Cast Acrylic, transferring thousands of hours of mould design and engineering into a tactile form. At Arctic Spas®, we hand apply layer after layer of a proprietary filler-free fiberglass composite material to give this form its legendary strength. We apply more fiberglass than anyone else in the business and no cost-saving shortcuts are taken; no plastic backing, no props or supports, and no foam is ever applied to our shell. After numerous procedures to check strength and alignment criteria, shells head to our state of the art water-jet robotic and CNC cutting stations for trimming. The result is a perfect blend of strength and accuracy and the backbone for the application of cutting edge technology that is signature Arctic Spas®. We are so confident in the strength of our hot tub shell that we offer a lifetime warranty on the shell structure. Please see our Warranty Document for more details.

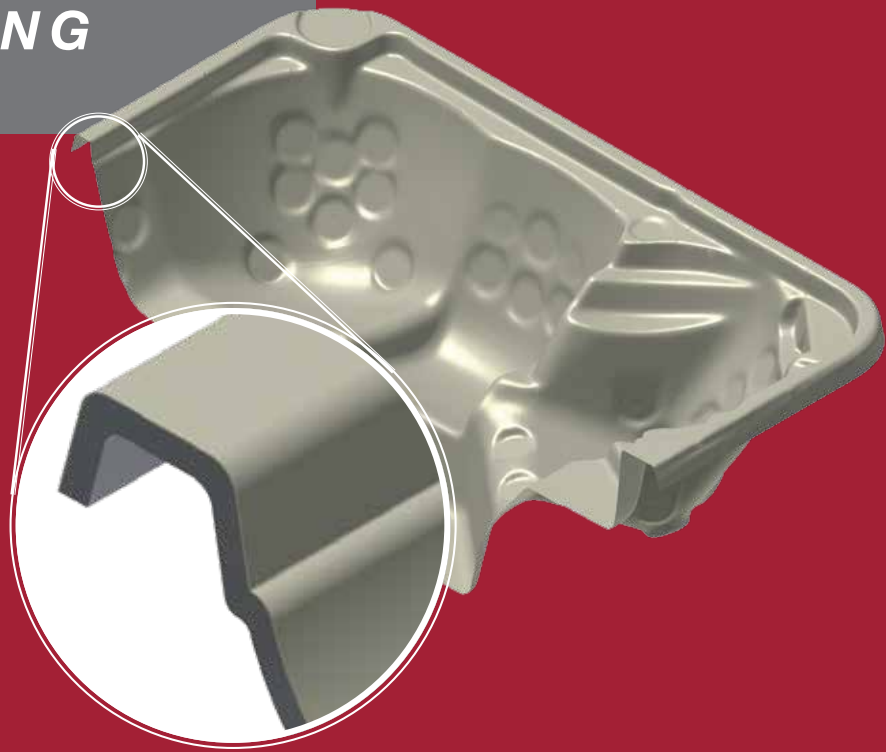

IS IT MORE COSTLY AND LABOUR INTENSIVE TO BUILD A SHELL THIS WAY?...ABSOLUTELY. BUT WE BELIEVE IT TO BE THE BEST WAY, AND THAT HAS ALWAYS BEEN OUR PURSUIT.



FOREVER FLOOR® THE PAD'S BUILT IN

All you need is level ground.

Already renowned for our sturdy insulated platform wood floor, standard on every Arctic Spa, our engineers decided to raise the bar yet again by developing the Forever Floor®. Composed of SMC fiberglass composites, this floor is impervious to moisture, pests and time. It completely eliminates the need for foundation materials like concrete, decking, or blocks!

Just set it on firm, level ground, hook it up, fill and use. Installation has never been easier and your floor will last forever in any conditions. In addition, your portable spa is now truly portable. If you move spa locations in your yard or if you move across town, the foundation comes with you. Be sure to order a Forever Floor® on your new Arctic Spa.



**Included with all Custom Series*



FREEHEAT™ INSULATION SYSTEM



Insulation in the right place saves you money, every day!

The investment in constructing a self-supporting shell allows Arctic Spas® to insulate differently than everyone else. For our design inspiration, we didn't have to look far, our homes in northern Canada provided us all we needed.

We insulate the exterior walls, the floors and most importantly the attics of our homes and we tuck everything important within this insulated envelope. Ambient heat from the pump penetrates the spa shell and heats the water. In winter this heat returns to the pump area in the event of a power loss.

We have always believed that insulation below the water surface is of small value if the areas above and directly to the sides of the water are not adequately insulated (seriously, doesn't heat rise?). The "attic" of our design is our Mylovac cover, which at 5" of thickness and featuring a full-length baffle is capable of retaining even more of your energy dollars. Next, high density polyurethane foam is applied to the cabinet walls and lip underside to a thickness that stops heat loss.

We finish off this insulation envelope with the same foam applied into our floor systems. Then, we place all our equipment inside this cocoon, creating a perfect, stable operating environment.

More Innovation

Any barrier between the equipment and the shell will prevent heat transfer and cost you money.

We have taken our insulation to the next level. Already the best insulated cabinet in the world, our FreeHeat™ Insulation system did not escape the exacting eye of our engineers.

Our overlap door insulation design removes the last opportunity for heat loss and captures even more residual equipment heat. To monitor this increased capacity for trapping waste heat, we have enabled our spa packs to take in internal cabinet temperature data and to activate the innovative RossExhaust™ system to balance the cabinet temperature when required. The ability to balance and manage the cabinet air temperature is such a unique and valuable feature that we have secured a patent on this system.

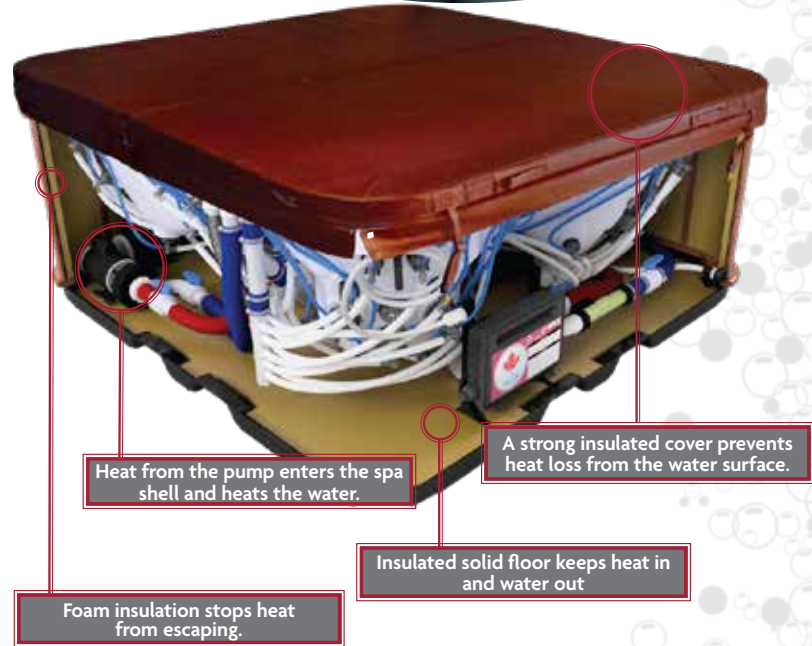

Lowest Running Costs.

What does this mean for the spa owner though? Residual heat from our equipment, primarily our High Flow Energy Efficient motors, is allowed to penetrate through the fiberglass shell. This maintains spa water temperature and eliminates many of the heater cycles that other designs, particularly foam-filled insulated designs have to run. Fewer heater cycles mean a lower power bill each and every month.

True Freeze Protection

One last benefit of the FreeHeat™ design that we hope you never need is the ability of the spa water's heat to keep the cabinet from freezing in a power outage situation. Without any insulation between the water and the cabinet, heat energy transfer can work in both directions. In our testing, and from anecdotal evidence, you have about 7 days, at -20°C before freezing occurs within the cabinet and adding an alternate heat source (space heater, trouble light) can prolong this grace period indefinitely. Other brands can start to freeze within a few hours in these conditions. Nice to have some margin for error, isn't it?

OTHER SPAS: BEWARE!



A full foam cabinet does not allow heat from the motors to get through to help heat the spa water and makes spa repairs extremely difficult and expensive.

Heat cannot penetrate foam under spa cabinet and it has nowhere else to go but into the atmosphere - this effectively wastes your money.

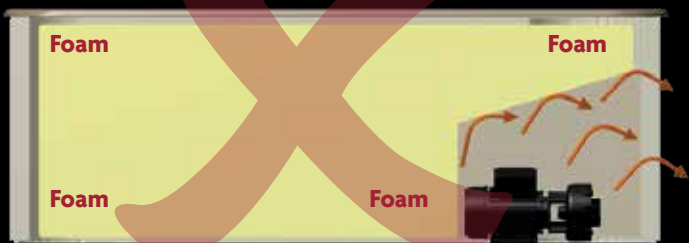

Any barrier between the equipment and the shell will prevent heat transfer and **cost you money.**



WESTERN CANADIAN RED CEDAR CABINETS

Nature's Perfect Building Material

Beauty, strength and accessibility are built into every Arctic Spas® cabinet. We construct each cabinet using kiln-dried, clear, furniture-grade Western Red cedar. This product is uniquely suited for our purpose, it has remarkable ability to thrive in a wide range of temperatures, humidities, and a high resistance to pests. In our design the corners are rounded with tongue-and-groove vertical cedar dadoed into top and bottom 2 x 4 rails. The sturdiness of our cabinets is incomparable. No sagging, shifting or misalignment will occur. All come with up to eight inset access doors, two on each side, allowing easy service and upgrades to any part of the spa. To finish the cabinet, three coats of a special, protective wood treatment is applied.



NO MAINTENANCE CABINETS

Our No Maintenance cabinet borrows from our tried and proven cedar cabinet that is built for strength and longevity, we have replicated this beautiful and functional design in 100% composite materials.

Solid top and bottom rails and vertical surfaces are all HighWood composite material – highly resistant to the ravages of sun and weather, providing a true “no maintenance” exterior to your Arctic Spa.

CHARCOAL



SABLE



CORE NO MAINTENANCE CABINETS



Graphite Grey



Purple Rain



Coastal Grey



Redwood



TOTAL ACCESS

Being able to get to all spa components in the future just makes sense.

All Arctic Spas® come standard with insulated removable access panels on all sides of the cabinet. Many companies bury hundreds of potential problems completely in foam, effectively ensuring that service is a nightmare when this foam needs to be removed and replaced to perform any service. With an Arctic Spa, it's simple!

Total Access also gives you the ability to upgrade your spa in the future. As we develop technologies or as your needs change, your Arctic Spa can easily be upgraded. There is no need to trade in your spa every few years when we can simply add jets, pumps, lights, music, purification or any other features in the future. Having to trade your spa in every few years to keep up with technology will get very expensive.



REFLEX TORSION™ HOSE

Better performance, fewer problems.

Arctic Spas® is the first company in the industry to use Reflex Torsion™ hose in every spa. This highly specialized pipe is designed to fit externally over rigid PVC, which allows greater gluing surface, higher water flow and eliminates fitting leaks due to hose movement. Water in the spa hoses can be heavy and this pipe actually swells to absorb stress from the fittings.

Reflex Torsion™ hose is clear with a colour-coded strand of PVC running through it. This makes for easy troubleshooting and allows us to see the coloured glue when we water-test each spa at the factory. If repairs are ever needed, a Reflex Torsion™ hose can usually be fixed with a hose clamp, long before a leak location in a full foam spa can be determined.





MYLOVAC™
THE WORLD'S FINEST COVER

Longest Lasting Cover, Period!

To top it all off, we offer an optional upgraded cover that is unlike any other in the industry. The Mylovac™ cover starts with foam twice as dense as the industry average. We also insert a metal “C” channel into the foam centers. This creates a cover capable of supporting thousands of pounds of weight. Never worry about snow loads or kid loads again. We then wrap these inserts in a metal/poly bag (similar to a coffee bag). This bag is then vacuumed and heat sealed. This technology is the only system that is capable of completely keeping moisture off of your cover inserts. Wet and heavy covers result in constantly increasing running costs as well as regular cover replacement.

Longer wind flaps, locking straps, carry handles, and an insulating baffle along the entire seam, finish off the best cover in the industry. This cover will save you thousands over the life of owning your spa.



GRAY

BROWN



**Included with all Custom Series*



MYLOVAC™
WEATHERSHIELD

This option is available in Dark Gray and Dark Brown. Ask your Dealer for details.

GRAY

BROWN





TITANIUM™ HEATER

Guaranteed for five years, no questions asked.

Arctic Spas® optional Titanium™ heater uses the latest in heating technology to maximize efficiency and reliability for your peace of mind. The Titanium™ heater has a titanium element that prevents the buildup of minerals, and is corrosion resistant to stand up to the harsh environment. On top of that, the no fault warranty covers the heater element for a full 5 years.



HIGH EFFICIENCY AQUAFLOW PUMPS

Better Engineering always results in Better Performance and Efficiency.

When sourcing the ultimate motor for a hot tub, two factors stand in the forefront for consideration. Water flow and efficiency. We want great water flow to provide the best massage possible when pumps are on high speed. We also are concerned about water flow on low speed or when the tub is filtering. Higher flow rates during filtration do a much better job of pulling contaminants into the filter media. On the other hand we want to do this while consuming the least amount of power.

Our R&D department solved both issues by sourcing out new High Efficiency Pumps. These pumps draw minimal amperage yet produce an extremely high volume of water flow. This is especially important on our filtration cycles. These pumps have a low speed amp draw that rivals a circulation pump but still move approximately 50 gal/min through the filters during filtration. And on high speed they accomplish the same thing; better flow with lower power consumption. Keep in mind, higher horsepower does not always equate to better performance. It always comes back to engineering.

And in every Arctic Spa we attach our motors using a specially designed vibration dampening mounting bracket that keeps them running whisper quiet.

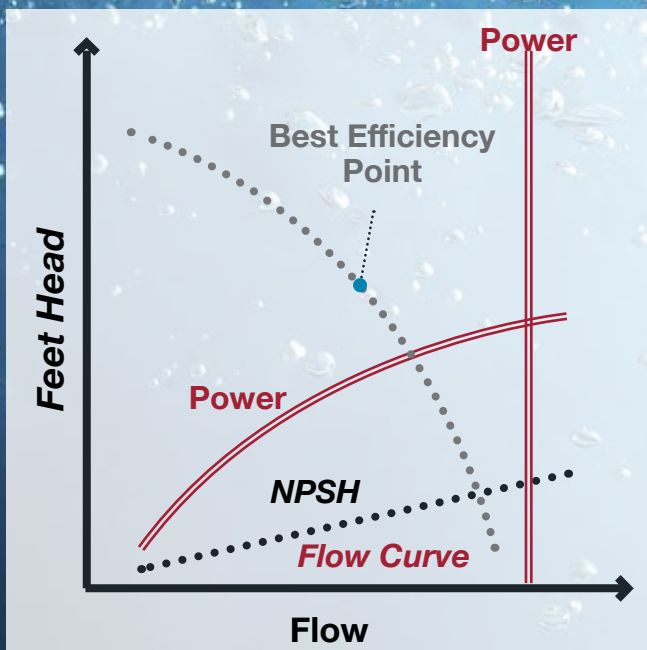



ONSPA®

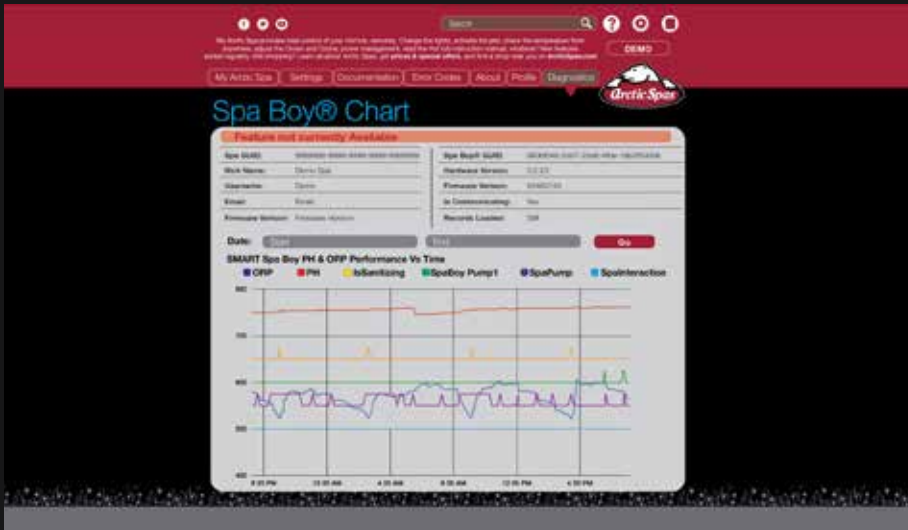

OnSpa® was introduced way back in 2011 and keeps getting better and more advanced every day. This advanced control system originally enabled full control of your Arctic Spa with your smart phone. It has evolved to be much more and continues to have new features added on a regular basis.

OnSpa® is a control system that enables 2-way internet communication and control.

OnSpa® allows you to monitor and control your hot tub from anywhere in the world using the Arctic Spa App on your phone or via the myarcticspa.com web portal.

OnSpa® allows our technicians to monitor and access your hot tub in real time, from anywhere in the world, anytime.



Wi Fi





OnSpa® also allows a steady stream of data from thousands of Arctic Spas around the world to be collected and analyzed on an ongoing basis. This data is used to make improvements in energy efficiency, performance, and reliability. It also allows us to detect malfunctions and issues that need attention before you even notice. Often, our technicians will detect and then remotely fix an issue before you even know about it. In cases where a technician needs to fix an issue on site, we can detect the problem and contact you to make a service appointment even before you are aware anything is wrong.

OnSpa® is allowing us to deliver a whole new level of customer service that the hot tub industry has never seen before.

The core component of this must-have option is the EcoPack. This is the on board Arctic Spa computer. Pair the EcoPack with your home internet connection and **OnSpa®** becomes activated and all of the benefits are yours.

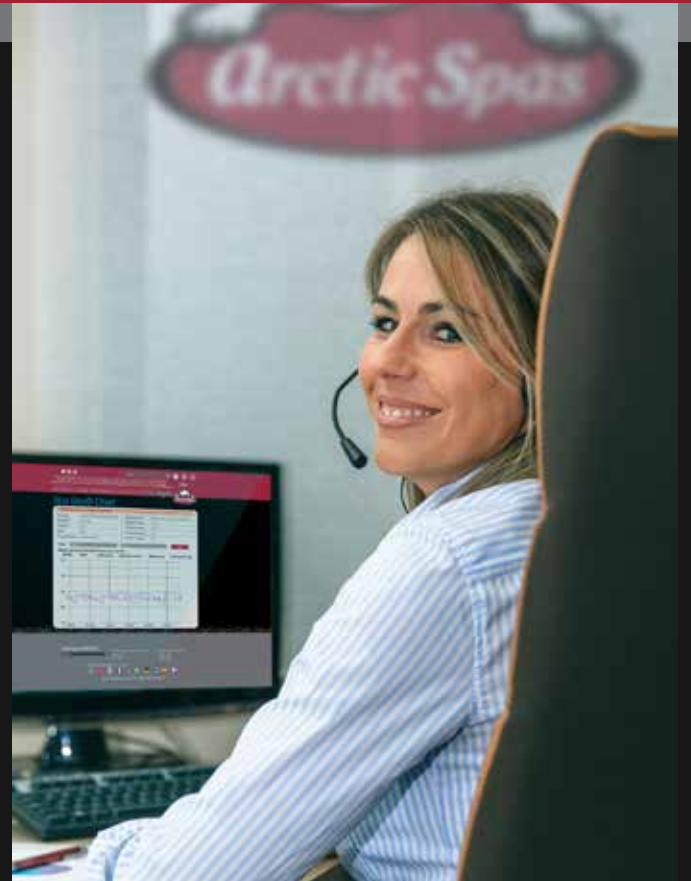



SPA BOY®

AUTOMATED SALT WATER CARE



Cutting Edge Exclusive to Arctic Spas®



Our automated water care system, **Spa Boy®** represents the most important advancement to hot tubs in many years. Rather than solely relying on inconvenient and imprecise manual testing and addition of sanitizer to your spa, **Spa Boy®** monitors, and helps maintain ideal spa water conditions. **Spa Boy®** simply, accurately and effortlessly helps to maintain perfect clear and safe spa water for you. This incredible technology uses medical-grade sensors to constantly analyze key water cleanliness parameters and from this data, the **Spa Boy®** system precisely controls the output of our integrated salt water system, ensuring that sanitizer levels are kept in the absolute optimum range. Should your spa's pH value come slightly out of balance, **Spa Boy®** alerts the spa owner (via the topside control panel, the app and the myarcticspa.com portal) to correct this condition.

Spa Boy®, has also completely changed the bathing experience. Relax in a soft and silky high sodium low saline bath that feels absolutely amazing on your skin with no chemical smell. Enjoy your Arctic Spa to its fullest potential, and leave water maintenance to your own, personal **Spa Boy®**!



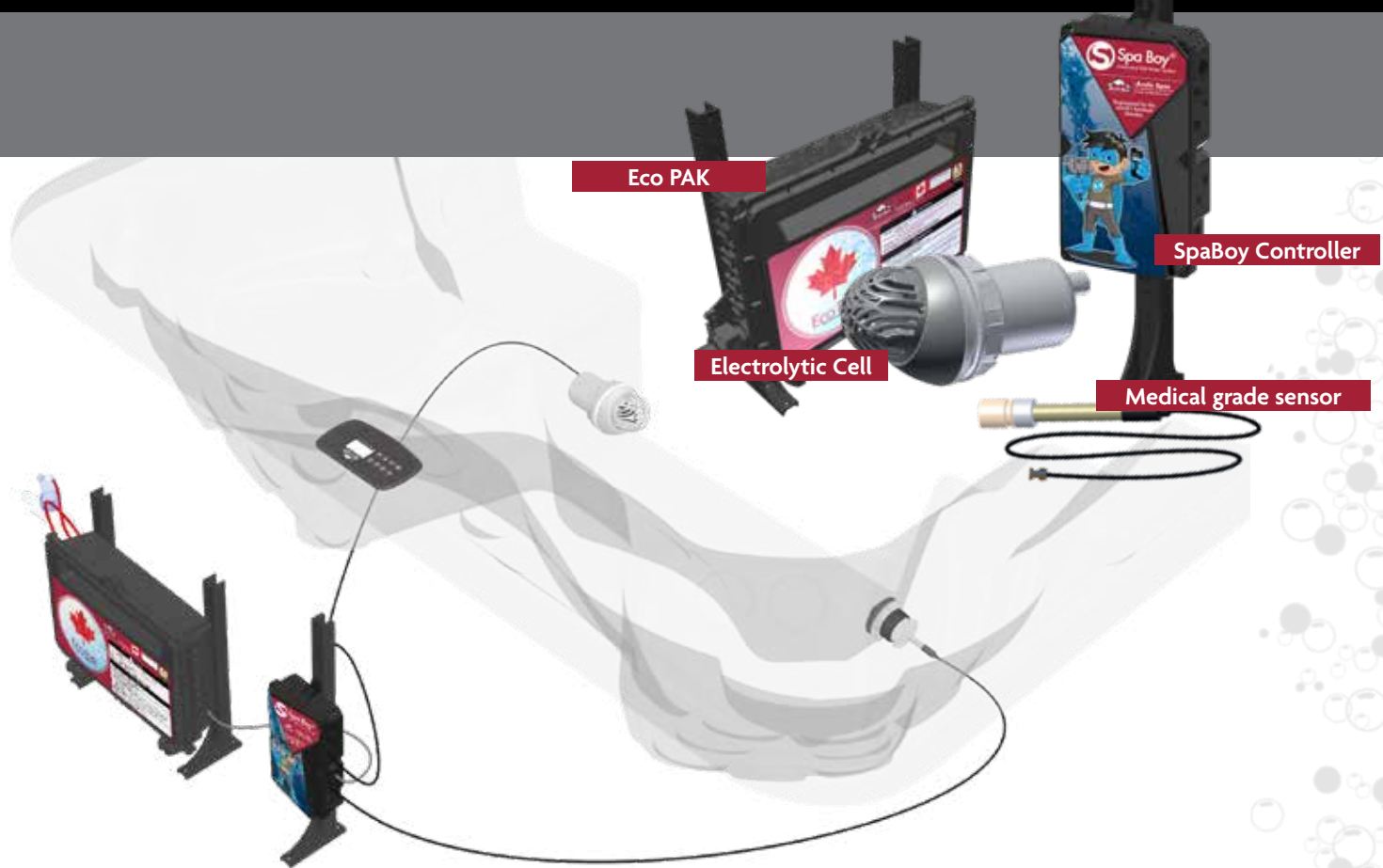

A **medical grade sensor** measures ORP and pH for water quality. The **Spa Boy® controller** analyzes the data and activates the **electrolytic cell** when the water quality drops below the set point. The **EcoPack** control system integrates Spa Boy® with the main hot tub controls and enables 2 way communication with the Arctic Spas App or myarcticspa.com via the internet.



YESS
OXYGEN SKIN THERAPY

The amazing oxidizing process that occurs with **YESS**, works alongside Spa Boy® to provide a water purification system, now available on Arctic Spas® Custom Series. This system saturates the water with millions of microscopic oxygen bubbles. These tiny bubbles enter your pores, attach to impurities and draw them away. It's like giving your whole body an oxygen facial. Your skin will be left feeling soft smooth and silky. The oxygen also stimulates skin health and cell regeneration. All this while enjoying a luxurious soak in your Arctic Spa and a bathing experience like no other found in the industry.





PEAK OZONE SYSTEM



Reliable and Highly Effective Ozone integration

During filtration, water moves through an area where it is exposed to activated oxygen or ozone, which provides remarkable oxidation. Highly concentrated ozone is created within our twin Failsafe™ generators, and then is injected into the water. The mixture of water and ozone is suspended in the turbulent Vertical mixing chamber to significantly increase the contact time of ozone with water. This process results in many of the organic compounds being oxidized, leaving less work for the sanitizing products to do.



AQUANOVA UVC/OZONE SYSTEM

The AquaNova™ rapidly eliminates 99.9% of all bacteria and viruses it comes in contact with. Also eliminating chlorine by-products that cause skin and eye irritation.

Using innovative technologies, the AquaNova™ combines ozone generation with UV-C sterilization to make your spa water safe and clean while reducing harsh chemicals.





ONZEN™ SALT WATER SYSTEM

The Onzen™ Salt Water system is Arctic Spas® proprietary salt water system that produces sanitizer from Dead Sea salts through the process of electrolysis. Salt-water sanitizer generation has several advantages over traditional sanitizer methods. Firstly, sanitizer is created, rather than added to the system and so there is very little on-going cost related to this system. The resulting spa water is much more gentle to skin and eyes, and has a similar salinity to a human tear.

Onzen™ has many unique features that have overcome previous challenges tied to salt water systems for spas. The first is that Onzen™ has a user-replaceable electrode cartridge. Electrolysis is a sacrificial process the electrodes will eventually deteriorate and require replacement.

The replacement of the Onzen™ titanium electrode cartridge is a simple and inexpensive maintenance item that does not require the tub to be drained. The second key feature of Onzen™ is the ability to control the system either from the topside control, or via the Arctic Spas® smartphone App. This user adjustment can be used to match the sanitizer output of the Onzen™ system to the current, or anticipated bather load.

The use of the Onzen™ Salt Water system can significantly reduce the effort required to maintain clear and safe spa water, but we do suggest adding Peak Ozone to maximize the benefit of the Onzen™ Salt Water system.



ARCTIC PURE EXCLUSIVE SPA CHEMICAL LINE

Arctic Spas® authorized dealers can provide a full line of Arctic Pure® chemicals for your spa. Using the approved Arctic Pure system ensures that your chemicals are economical, filler and additive - free and give greater consistency to your water maintenance program. Be sure to ask for Arctic Pure brand water treatment products to maximize the life of your hot tub.





DUAL ACTIVE SKIM FILTRATION

Sparkling clean water, with minimum effort and the widest choice of user-customizable options

As Arctic Spas® continues to refine our patented filtration systems and develop new ideas, our goal has always been to keep your spa water safe and clean, and to do so with the least amount of work for the spa owner as possible.

Because of such vast differences in usage (bather load), source water quality, and other parameters, we realized that we needed to give the spa owner more choice. With some good advice from an authorized Arctic Spas® dealer, you now have many custom filtration and technology options.

Active Skim Filtration

Each Arctic Spa filter chamber houses our Active Skim Filtration mechanism, which constantly adjusts to the changing water level in your tub thus maintaining powerful surface skimming. With Active Skim Filtration, contaminants at the surface are drawn down into the filter regardless of water level, unlike typical systems. Additionally, the mechanism traps larger particles in an integrated basket, and does not allow them to be released back into the bather pool.

More Control = Cleaner Water

All Arctic Spas® come standard with an adjustable filter cycle system using low speed on pump 1 to do the filtering. This system is now programmable from 1 to 24 hours of run time.

Silver Sentinel 1 Micron Filters

These depth filters trap particles within the filter media (up to 900 sq. ft in each filter) and offer the additional benefit of embedded nano silver internal coating. At an amazing 1 Micron level of particle trapping, Silver Sentinel filters offer the highest level of filtration, and are disposable and recyclable. All Silver Sentinel Filters eliminate the need for many auxiliary de-foaming, clarifiers, filter cleaners and coagulating chemicals.

Compact Pleated Filter

This combination option provides the fine filtration of the Compact Pleated Filter technology with the versatility of a reusable bag filter. The microfiber bag filter can handle sporadic high-use or high-debris periods without requiring frequent replacement of the Pleated filter portion of the system.

Microfiber Filters

These simple but effective filters can be used to quickly clean up your spa water after periods of high use, or low maintenance. They can be rinsed and re-used, and are very affordable. Great to have a few on hand, ready to have your tub sparkling for a weekend of entertaining!

*Dual filter chambers not available on the Arctic Fox or Core Series.





NEW PROGRESSIVE "SMART" FILTRATION

Sparkling clean water with minimum effort and customizable options.

Years of engineering and testing have finally led us to what we believe is the finest filtration system available on spas today. This simple yet amazingly effective system uses multiple layers of different filter medias to effectively capture all sizes of particles found in spa water. We start with a very coarse media designed to catch large particles. We slowly decrease size of the media layers in the filter cartridge to catch the smallest particles in the water. We use 5 different types of media in the filters that allow each layer to catch the size of particle it was designed to. The result is amazingly clean water and significantly improved filter longevity.

Customizable.

As we continue to develop our Progressive Filtration System, we will be able to change the filter media layers to account for specific water situations. Areas with high iron can have an iron filter added; high calcium, a calcium filter etc. Water with more contaminants in a specific micron range can have more of that media added. The result will be custom built filters to provide the most effective and long lasting filters built specifically for your area.

With the OnSpa® app you will be able to determine what type of filter you have in your spa and when it was last changed.





COMFORT & THERAPY

Comfort, Comfort, Comfort

As spa seating designs have evolved over the years, at Arctic Spas® we've slowly been transitioning to more sculptured, comfortable designs. Our seats have been meticulously designed to wrap around and support a wide range of body dimensions, with multi-level armrests and adjustable headrests in all the right spots. Our shuttle seats are arguably the most comfortable seats in hot tubs. You will find some models with one as well as some with up to four of these ultimately comfortable locations. You're guaranteed to find one that fits you perfectly. Enjoy reading? These shuttle seats have multiple levels of raised armrests that provide the perfect rest to hold your book or tablet above the water level without tiring.

Within these sculpted seats we've taken great effort to position our jets to provide the best massage possible. All seats will be slightly different to provide a unique massage in each chair.



ARCTIC HEADRESTS FINALLY A PILLOW THAT WORKS.

After years of issues dealing with poorly placed, deteriorating pillows, we believe we've finally come up with the ultimate pillow design. Our new telescoping design adjusts to perfectly fit varying heights of bathers. The pivoting mechanism also cradles the neck to maximize the comfort. The pillows are still removable for cleaning but will never be found floating around the spa. Finally, we've changed the product the pillows are made from. Most pillows are made from a polyurethane foam. These pillows absorb water and can deteriorate quite quickly in a hot tub environment. Our new pillow is made of a rubber like material called EVA. This material (used for CROC™ shoes) unlike PU foam, does not absorb water or deteriorate rapidly.





PEPPERLEAF JETS AMAZING THERAPY JETS



Great jets give great therapy.

Arctic Spas® patented rotating, bearing-less Pulse™ jets provide a range of massage from light and refined to deep and invigorating. As the nozzle smoothly rotates on a titanium shaft, water oscillates in a pattern that never stings. Our jets thread in and out, so that removal is never a hassle, but still retain an adjustable face to vary the pressure as required.

With no ball bearings to ever seize and fail, your personal masseuse never takes a day off.



LOW PROFILE RIPPLE JETS SAME GREAT DESIGN

Simply Beautiful.

These sleek jets are engineered with the same Arctic Spas® patented rotating, bearing-less Pulse™ jets with the added beauty of stainless steel, resistant to corrosion and rusting.

These jets come standard with our **Custom Series**.





LIGHTING SYSTEMS



Northern Lights

Inspired by the Aurora Borealis of our northern winter skies, the Northern Lights system brings digital color changes and fades to your spa. With an extensive variety of patterns and sequences, you can choose the perfect lighting scheme for your mood... The system has two light locations that work together to fill your spa with color.



Family Lights

We are pleased to add another lighting package to the lengthy list of options available on your Arctic Spa. The Family Lighting Package features two underwater lights and uses elegant backlighting of the controls and drink holders along the top lip area of our spas. Additionally, "water-rope" waterfalls are also backlit. The numerous points of light in this package are digitally controlled, so the full range of lighting effects - static, multi-color, fades and patterns light up your beautiful Arctic Spa as you choose. Pick your favourite colour(s), select a soothing glow or a lively pattern - whatever the mood requires, the Family Lighting Package can accommodate.



Ultimate Lights

Arctic Spa lighting taken to the next level! In the Ultimate Lighting package, all jets are backlit through clear sections with technology that neither affects water flow, nor creates a leak potential. All controls and cup holders are backlit as well, and we top things off with beautiful sconces that house down light LEDs that illuminate and attractively accent our beautiful cabinets. All light sources are digitally controlled, and offer the full range of fades, solids and intermittent patterns. Ultimate Lighting is a beautiful addition to any Arctic Spa.

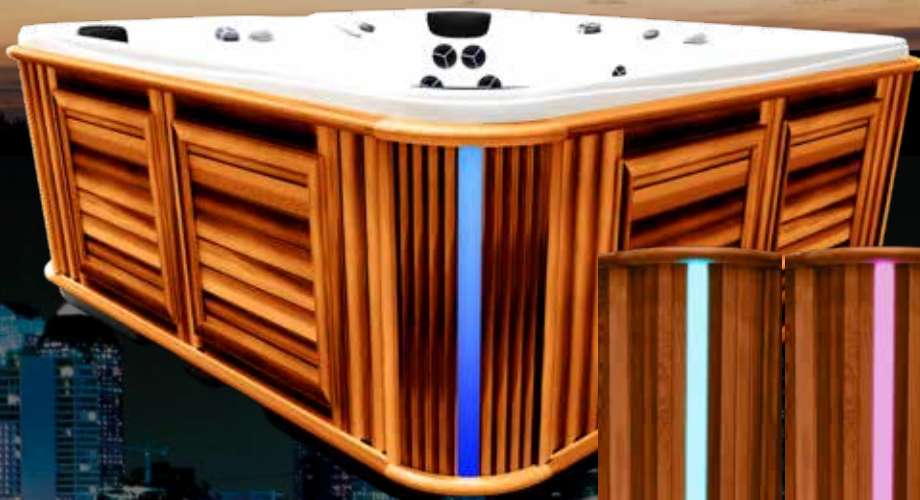

Corner Accent Lighting

An impressive touch which beautifully accents your cabinet and hot tubbing atmosphere. Made of polycarbonate, this upgrade is impact resistant, stands up to the elements and is available in our CUSTOM Series Hot Tubs.

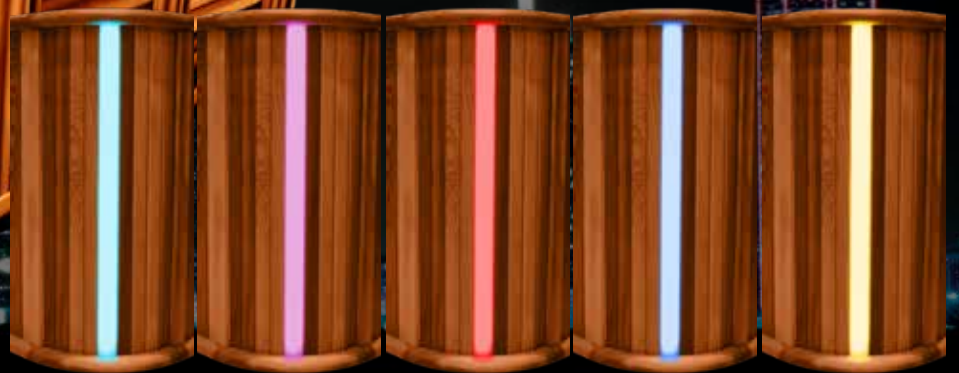



Arctic Spas® integrates comfort with technology with our bluetooth enabled music streaming systems.

All of your music can now stream from a Bluetooth-enabled device such as any Smartphone to your spa, so you have your playlists and all your content available at your fingertips. If you wish to use other spa-side devices, the system can be configured with a wired connection as well your older generation iPod, CD and TV audio all can be connected to these systems.

Sound FX.

To enhance your hot tubbing experience, all Core Series are available with marine grade stereo systems. Two flush mounted speakers paired with a Bluetooth amp and sub woofer deliver superior sound quality.

Control of your music is provided via wireless Bluetooth signal to your compatible device. A convenient supplemental control pad is also mounted on the spa side wall.

WetTunes™.

Take your hot tubbing enjoyment to a new level, all Classic Series tubs are available with the WetTunes™ stereo option with beautiful Poly Planar™ air-rise speakers. These speakers provide fantastic sound while providing great

durability in adverse conditions and are mated to a powered subwoofer, delivering thumping low-end sound from within our FreeHeat™ cabinet.

Aquatremor® Stereo System.

Boost your experience, all Custom Series are available with the remarkable Aquatremor® sound technology. The basis of the Aquatremor® stereo system is the use of tactile transducers rather than speakers. These transducers are bonded to the shell and cabinet and drive sound through both solids and liquids with incredible clarity, effectively turning the spa shell, the cabinet and the spa water into the “speaker”.

As the human body is composed primarily of water, the sound waves pass through you as you relax in the water, so not only are you hearing the music it surrounds you, moves through you and you truly feel it! Every Arctic Spa mould design now has a signature Aquatremor® Seat, giving the music lover the most direct connection to the music possible. Also available with Aquatremor® is our downloadable vibro-acoustic massage. These massaging audio tracks use very low frequency tones to massage different muscle groups. It's a therapy that needs to be experienced.





SKYFALL®

FOGGER

Our new SkyFall® Fogger generates and cascades an ethereal mist onto the water's surface of your Arctic Spa. Without the noise and splash of conventional water features, SkyFall® adds a dramatic, yet soothing aspect to your hot tub experience.

The colour-changing SkyFall® LED backlighting accentuates the gentle motion of the mist, sequencing with your other lighting sources.



WATERFALL

EXPERIENCE

All of our CUSTOM and CLASSIC Series Spas come with this relaxing laminar four jet water feature. You can adjust this fine detail to create your perfect water flow and personal calming sound!

Available with our Family and Ultimate lighting options these jets are equipped with LED lighting that offer a full range of lighting effects that accentuate your soothing experience.



IN.TOUCH 2 INTERNET CONTROL

The ultimate mobile remote control for your spa,

in.touch 2 eliminates all the complexities of connecting your spa to the Internet and transforms your smartphone or tablet into your ultimate mobile remote control.

in.touch 2 streamlined iOS or Android application makes it very easy to control and program functions of your spa even when you're away from home. Push notifications will always keep you informed on the status of your spa, even when your app is not open.



PLUG & PLAY 110V

Looking For A Plug & Play Hot Tub?
Only Have 110V Power Supply?
Arctic Spas has you covered!

The 110V option is available in Arctic Spas 7' or smaller 1 pump models. This means you do not have to settle for an inferior quality hot tub in order to get the convenience and electrical install savings of a 110V powered hot tub





ARCTIC SPAS® COLOURS

The Arctic Spas® Exclusive acrylic line.

Dakota and Kalahari from Aristech are unique in that they are textured surfaces exclusive to Arctic Spas®.



Kalahari



Dakota

A surface you can feel comfortable resting against.

Choose the perfect match for your lifestyle and decor.



Odyssey



Platinum Swirl



Espresso

Custom and Classic Series available in

- Platinum Swirl
- Kalahari
- Dakota
- Espresso
- Odyssey

Core Series available in

- Platinum Swirl
- Kalahari
- Dakota
- Espresso

Summit XL available in

- Platinum Swirl
- Kalahari

All Weather Pools available in

- Platinum Swirl



THE POWER OF BIO-LOK™ MICROBE SHIELD

In addition to Aristech Acrylics' excellent gloss and color retention, our Bio-Lok™ surfaces are naturally impervious to microbes, without the need of added chemicals. The non-porous nature of Aristech's Bio-Lok sheet defends against the penetration and growth of microorganisms on its surface. Bio-Lok hot tubs are shielded against microbes, easy to clean, durable, and do not contain any anti microbial chemicals, pesticides or similar additives.



WARRANTY PARTS & LABOUR

Our CORE values

At Arctic Spas® we take pride and are committed to advanced engineering and quality craftsmanship to enhance your hot tubbing experience. As with all manufactured products, things happen and if a problem does occur our parts and labour warranties have you covered.

CUSTOM - 5 years Parts 5 years Labour

CLASSIC - 3 years Parts 3 years Labour

CORE - 3 years Parts 1 year Labour





You Deserve It!

START FEELING GREAT EVERYDAY, ANYTIME, IN 4 EASY STEPS



1

CONTACT

US



2

SELECT
YOUR SPA

We will help you choose the size, model, and options that are best for you.



3

PREPARE FOR
DELIVERY

Preparation is very minimal and our team will guide you every step of the way.



4

INSTALL
& ENJOY

Simply fill it with your garden hose, wait for it to heat up and enjoy! We make it easy.





V2-052020



Arctic Spas® may make product modifications and enhancements without notice. Specifications and dimensions are approximate and for reference only. Printed in Canada.